

PHILIPS

Kylis
9290033621



User manual
Benutzerhandbuch
Notice d'emploi
Manual de usuario
Manual do usuário
Manuale d'uso
Gebruiksaanwijzing

Incl.

A



B

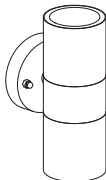

Excl.



x2



B



IP44



3/8"

8mm



GU10



MAX. 25W



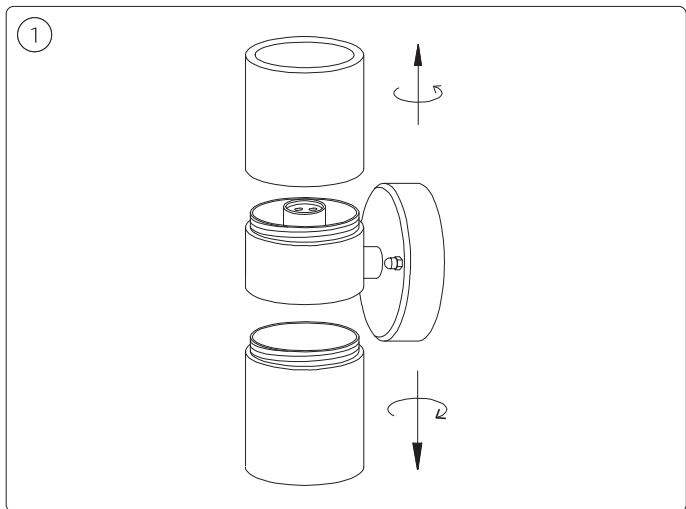
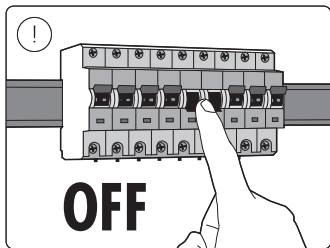

2

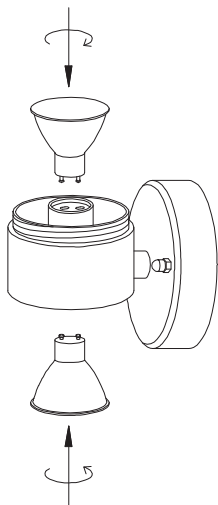

3

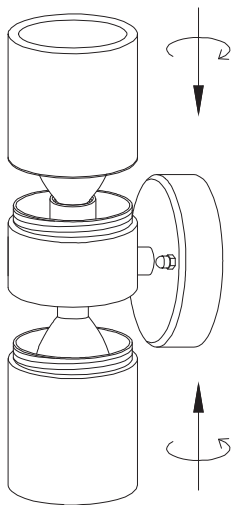

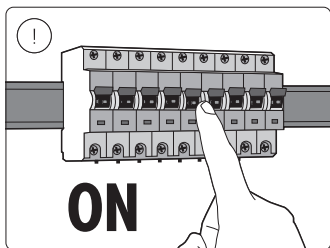
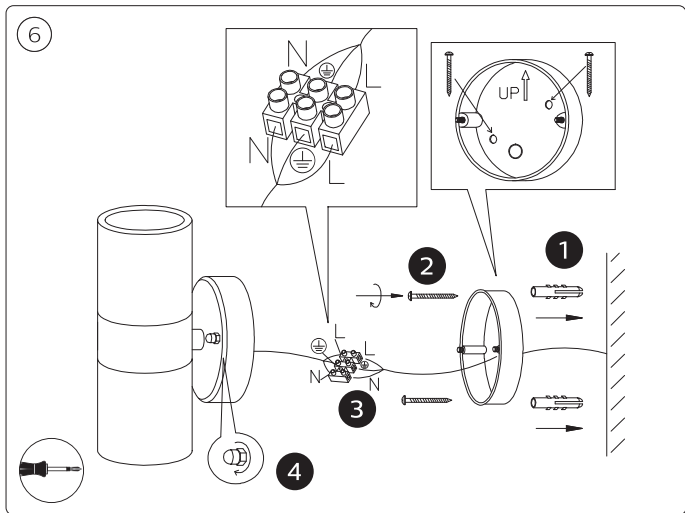



Signify Commercial UK Limited
Unit 3, Guildford Business Park,
Guildford, Surrey, GU2 8XG, UK

Signify
I.B.R.S. / C.C.R.I. Numéro 10461
5600 VB Eindhoven,
the Netherlands
Ø00800-74454775

Philips and the Philips Shield Emblem are registered trademarks
of Koninklijke Philips N.V. and are used under license

3241 660 97161
www.philips.com/lighting

© 2023 Signify Holding

The Signify logo, which consists of a stylized 'S' inside a circle followed by the word "signify" in a lowercase, sans-serif font.